



Origin3400 Solar System Panel Specifications

Your Origin system will be supplied with one of the following sets of panels:

Manufacturer	Mono Or Poly	Size (Watts)
Suntech	Mono	190
Trina Solar	Mono	190/195/200

Please note all solar panels supplied are CEC accredited and compliant with IEC/EN61730 and IEC/EN61215 or IEC/EN61646.

The choice of panels will be at the **sole discretion** of our installer subject to such matters as stock availability.

Please see the following specification sheet for further details and panel specifications.

STP190S - 24/Ad+ STP185S - 24/Ad+

190 Watt

MONOCRYSTALLINE SOLAR MODULE

Features



High module conversion efficiency (up to 14.9%), through superior manufacturing technology



Guaranteed 0-5W positive power output tolerance ensures high reliability



Proprietary Gallium-F22 doping process dramatically reduces initial light-induced degradation to <1%, thus delivering better power and performance over time



New Jumbo cells with 4% larger solar cell area produce more power per module



Entire module certified to withstand high wind loads (2400 Pascal) and snow loads (5400 Pascal) *



Trust Suntech to Deliver Reliable Performance Over Time

- World's leading manufacturer of crystalline silicon photovoltaic modules
- Unrivaled manufacturing capacity and world-class technology
- Rigorous quality control meeting the highest international standards : ISO 9001: 2008 and ISO 14001: 2004
- Certification and standards: IEC 61215, IEC 61730, conformity to CE

Industry-leading warranty

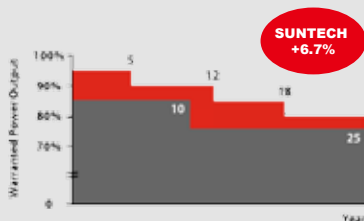

- 25 year transferrable power output warranty: 5 year/95%, 12 year/90%, 18 year/85%, 25 year/80% **
- Based on nominal power
- Warrants 6.7% more power than the market standard over 25 years
- 5 year material and workmanship warranty

* Please refer to Suntech Standard Module Installation Manual for details.

** Please refer to Suntech Product Warranty for details.

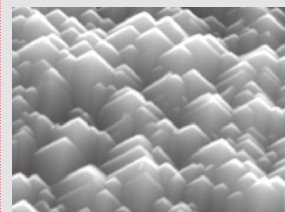

Patented surface pyramids enhance sunlight absorption by redirecting reflected light to other areas on the cell surface to be reabsorbed

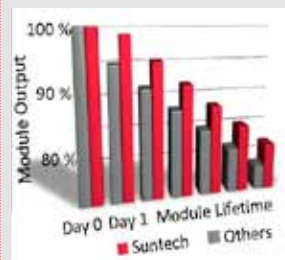

Suntech cells feature a breakthrough process that replaces traditional boron doping with gallium doping. The effect of initial light-induced degradation is dramatically reduced, leading to greater power output over the entire module lifetime.

Graph is for illustration only and does not imply any guarantee of module performance. Please check warranty for details.

STP190S - 24/Ad+
STP185S - 24/Ad+

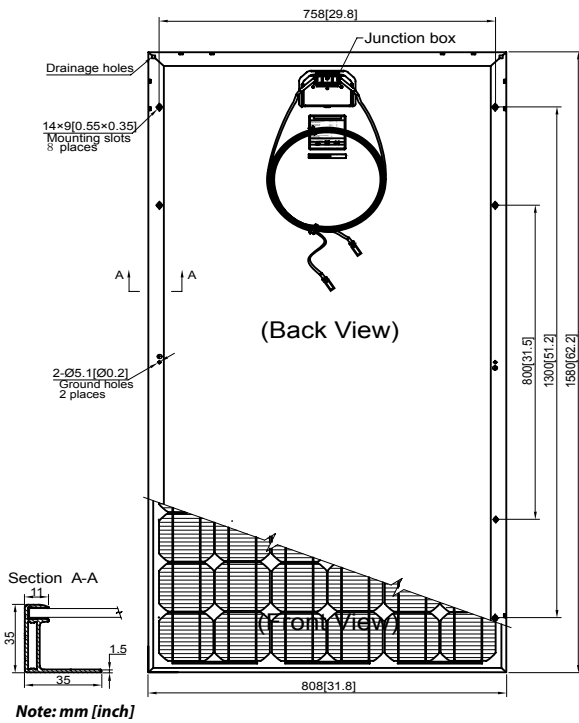

Current-Voltage & Power-Voltage Curve (190S-24)

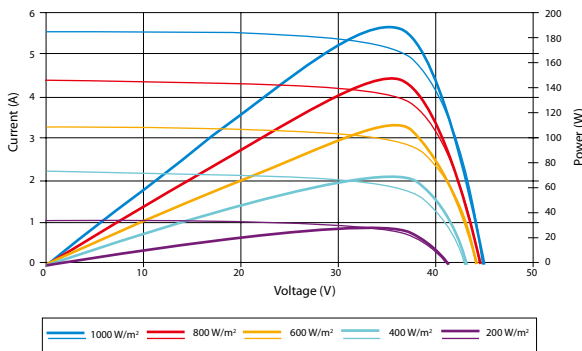

Temperature Characteristics

Nominal Operating Cell Temperature (NOCT)	45±2°C
Temperature Coefficient of Pmax	-0.48 %/°C
Temperature Coefficient of Voc	-0.34 %/°C
Temperature Coefficient of Isc	0.037 %/°C



Electrical Characteristics

STC	STP190S-24/Ad+	STP185S-24/Ad+
Optimum Operating Voltage (Vmp)	36.5 V	36.4 V
Optimum Operating Current (Imp)	5.20 A	5.09 A
Open - Circuit Voltage (Voc)	45.2 V	45.0 V
Short - Circuit Current (Isc)	5.62 A	5.43 A
Maximum Power at STC (Pmax)	190 W	185 W
Module Efficiency	14.9%	14.5%
Operating Temperature	-40 °C to +85 °C	-40°C to +85°C
Maximum System Voltage	600 V DC	600 V DC
Maximum Series Fuse Rating	15 A	15 A
Power Tolerance	0/+5 W	0/+5 W

STC: Irradiance 1000 W/m², module temperature 25 °C, AM=1.5

NOCT	STP190S-24/Ad+	STP185S-24/Ad+
Maximum Power (W)	139 W	135 W
Maximum Power Voltage (V)	33.1 V	33.0 V
Maximum Power Current (A)	4.19 A	4.10 A
Open Circuit Voltage (Voc)	41.3 V	41.0 V
Short Circuit Current (Isc)	4.56 A	4.40 A
Efficiency Reduction (from 1000 W/m ² to 200 W/m ²)	<4.5%	<4.5%

NOCT: Irradiance 800 W/m², ambient temperature 20 °C, wind speed 1 m/s

Mechanical Characteristics

Solar Cell	Monocrystalline 125 × 125 mm (5 inches)
No. of Cells	72 (6 × 12)
Dimensions	1580 × 808 × 35mm (62.2 × 31.8 × 1.4 inches)
Weight	15.5 kgs (34.1 lbs.)
Front Glass	3.2 mm (0.13 inches) tempered glass
Frame	Anodized aluminium alloy
Junction Box	IP67 rated
Output Cables	H+S RADOX® SMART cable 4.0 mm ² (0.006 inches ²), symmetrical lengths (-) 1000 mm (39.4 inches) and (+) 1000 mm (39.4 inches), H4 connectors (MC4 compatible)

Packing Configuration

Container	20' GP	40' GP
Pieces per pallet	26	26
Pallets per container	12	28
Pieces per container	312	728

Specifications are subject to change without further notification

Mono

Multi

Solutions

TSM-DC01A

TSM-DA01A

THE **Comax** SOLUTION
by **TrinaSolar**



15.6%
MAX EFFICIENCY

200W
MAX POWER OUTPUT

10 YEAR
PRODUCT WARRANTY

25 YEAR
LINEAR POWER WARRANTY

Founded in 1997, Trina Solar is a vertically integrated PV manufacturer, involved in the production of ingots, wafers and cells to the assembly of high quality modules, using both mono and multicrystalline technologies. As of July 2011, the Company has already achieved an annualized nameplate module capacity of approximately 1.9GW. Trina Solar's wide range of products are used in residential, commercial, industrial and public utility applications throughout the world.

Only by matching an efficient cost-structure with proven performance will we as an industry achieve grid parity. And at Trina Solar, we have both.

Trina Solar Limited
www.trinasolar.com

TrinaSolar
The power behind the panel



Module can bear snow loads up to **5400Pa** and wind loads up to **2400Pa**



Guaranteed power output
0~+3%



High performance under low light conditions
Cloudy days, mornings and evenings



Optimized corners increase output
up to **195W**



Independently certified by **international certification bodies**



Manufactured according to International Quality and Environment Management System Standards
ISO9001, ISO14001

LINEAR PERFORMANCE WARRANTY

NEW

10 Year Product Warranty • 25 Year Linear Power Warranty

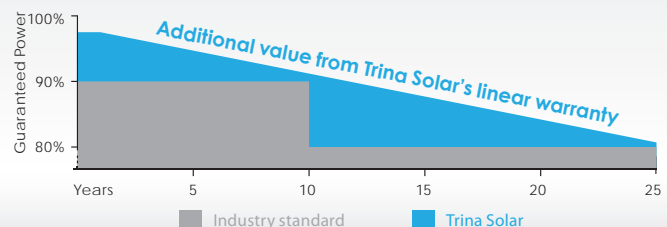

TSM-DC01A / TSM-DA01A THE Comax SOLUTION

by TrinaSolar

DIMENSIONS OF PV MODULE TSM-DC/DA 01A

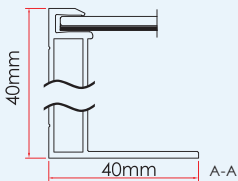
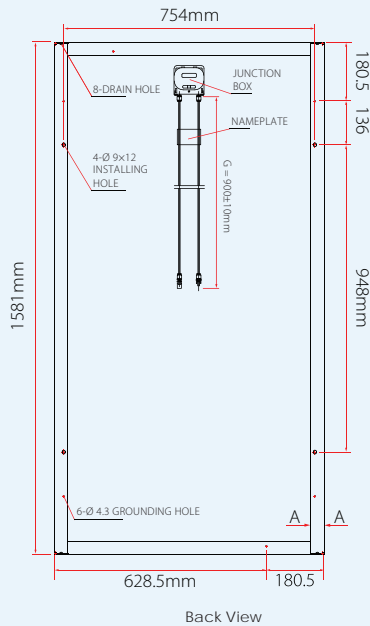

I-V CURVES OF PV MODULE TSM-190 DC/DA 01A

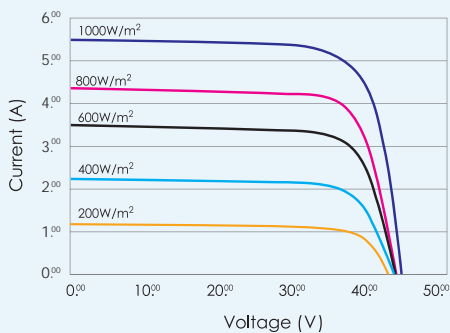

Average efficiency reduction of 4.5% at 200W/m² according to EN 60904-1.

CERTIFICATION



ELECTRICAL DATA @ STC	TSM-190 DC/DA01A	TSM-195 DC/DA01A	TSM-200 DC/DA01A
Peak Power Watts-P _{MAX} (Wp)	190	195	200
Power Output Tolerance-P _{MAX} (%)	0/+3	0/+3	0/+3
Maximum Power Voltage-V _{MP} (V)	36.6	37.1	37.6
Maximum Power Current-I _{MPP} (A)	5.19	5.25	5.32
Open Circuit Voltage-V _{OC} (V)	45.1	45.6	46.0
Short Circuit Current-I _{SC} (A)	5.52	5.56	5.60
Module Efficiency η _m (%)	14.9	15.2	15.6

Values at Standard Test Conditions STC (Air Mass AM1.5, Irradiance 1000W/m², Cell Temperature 25°C).

ELECTRICAL DATA @ NOCT	TSM-190 DC/DA01A	TSM-195 DC/DA01A	TSM-200 DC/DA01A
Maximum Power (W)	140	143	147
Maximum Power Voltage (V)	33.8	34.3	34.8
Maximum Power Current (A)	4.14	4.18	4.23
Open Circuit Voltage (V)	41.7	42.2	42.5
Short Circuit Current (A)	4.44	4.47	4.5

NOCT: Irradiance at 800W/m², Ambient Temperature 20°C, Wind Speed 1M/s.

MECHANICAL DATA	
Solar cells	Monocrystalline 125 × 125mm (5 inches)
Cell orientation	72 cells (6 × 12)
Module dimension	1581 × 809 × 40mm (62.24 × 31.85 × 1.57 inches)
Weight	15.6kg (34.4 lb)
Glass	High transparency solar glass 3.2mm (0.13 inches)
Frame	Anodized aluminium alloy
J-Box	IP 65 rated
Cables / Connector	Photovoltaic Technology cable 4.0mm ² (0.006 inches ²), 900mm (35.4 inches), MC4

TEMPERATURE RATINGS		MAXIMUM RATINGS	
Nominal Operating Cell Temperature (NOCT)	46°C (±2°C)	Operational Temperature	-40~+85°C
Temperature Coefficient of P _{MAX}	-0.40%/°C	Maximum System Voltage	1000V DC(IEC)/600V DC(UL)
Temperature Coefficient of V _{OC}	-0.30%/°C	Max Series Fuse Rating	10A
Temperature Coefficient of I _{SC}	0.023%/°C		

WARRANTY	
10 year workmanship warranty	
25 year linear performance warranty	
(Please refer to product warranty for details)	

PACKAGING CONFIGURATION	
Modules per box: 23 pcs	
Modules per 40' container: 644 pcs	

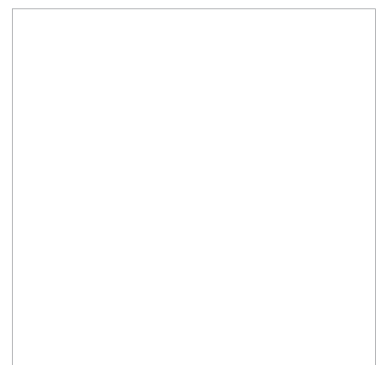

TSM_EN_Feb_2012