



Basic Product Information

- Designed for High Voltage batteries (e.g. Tesla Powerwall).
- AC Coupled solution, suitable for:
 1. Retrofit (SMA or 3rd party PV system), *including the 1.5 million existing Australian residential PV systems*
 2. New installation (SMA or 3rd party PV system)
 3. Storage without PV plant
- Connects easily to the SMA Energy Management System.
- Sunny Boy Storage allows customers to choose their battery:
 - Brand
 - Size/Capacity
 - Technology (e.g. Li-ion, etc)
- Australia identified by SMA as initial market for product.
- First units due off the Production Line March 2016, arriving in Australia in Q2.



SUNNY BOY STORAGE

Cost-effective, flexible and simple



Technical Data

Battery integration	AC-Coupled
Inverter Type	Battery inverter only
Topology	Transformerless
Grid Connection	Single Phase
Power (ch./disch.)	2.5 kW
DC-Voltage (Batt.)	120 V - 500 V _{DC}
DC-Current/Max	10 A / 18 A
Efficiency (max.)	97 % (Batt. → Grid)
Weight (approx)	9kg
Dimensions (W/H/D)	~460 x 360 x 120mm



Advantages:

- > **Flexibility due to AC-coupling**
 - > New installations, Retrofit, Battery only
 - > Flexible PV-design
 - > Free choice from several Batteries (e.g. TESLA, etc.)
- > **Cost-effective and efficient**
 - > Based on SMA's proven String-technology
 - > Best-price battery-inverter
 - > Efficiency up to 97%
- > **Quick and easy to install**
 - > Integrated Wireless and Web Server, for commissioning via Smart Phone
 - > Direct integration into Sunny Portal/Sunny Places via Webconnect (WiFi or Ethernet)

SUNNY BOY STORAGE



Basic Single Line Diagram (preliminary)

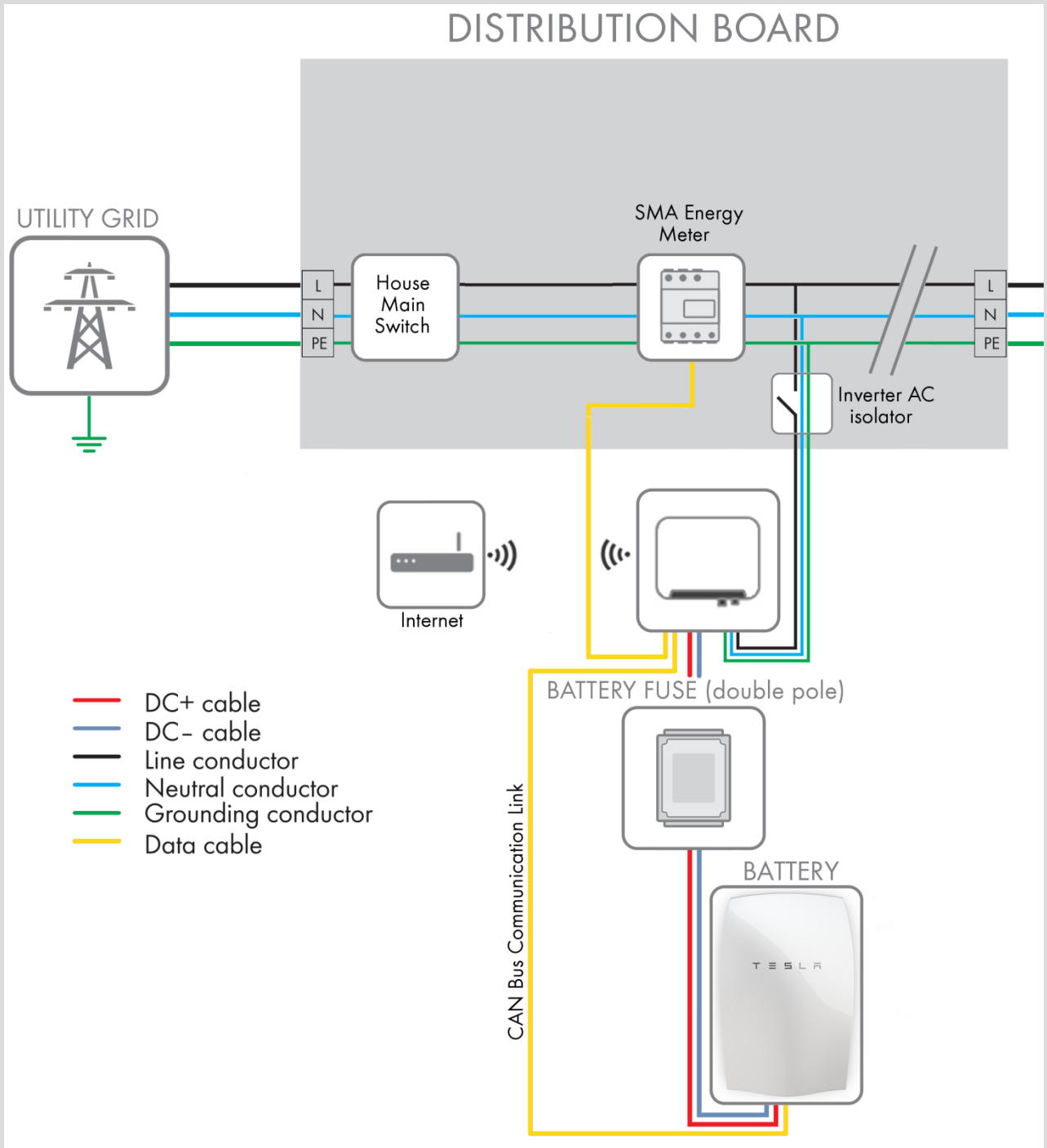

SUNNY BOY STORAGE



Basic Generic System

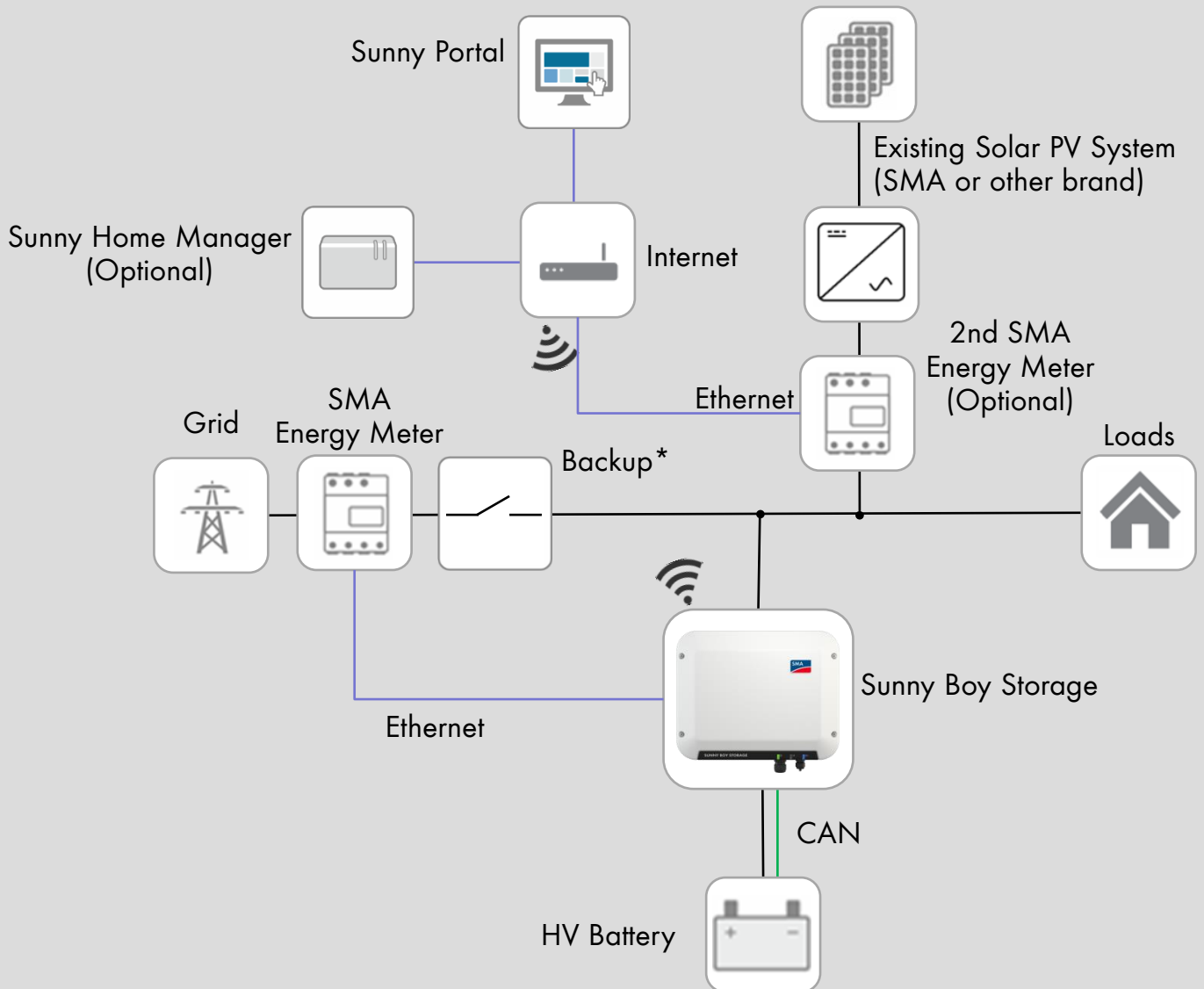

* Backup as retrofit kit (Q4/2016)

SUNNY BOY STORAGE



Basic SMA System

System components

- > SMA 1ph or 3ph. PV-Inv. incl. Webconnect
- > SMA Energy Meter
- > Sunny Boy Storage

Functions

- > Control to the grid connection Point via SMA Energy Meter
- > Export limitation between 0-100% of rated power
- > Visualization Sunny Portal
- > Modbus third-party interface
- > CAN-BUS battery interface

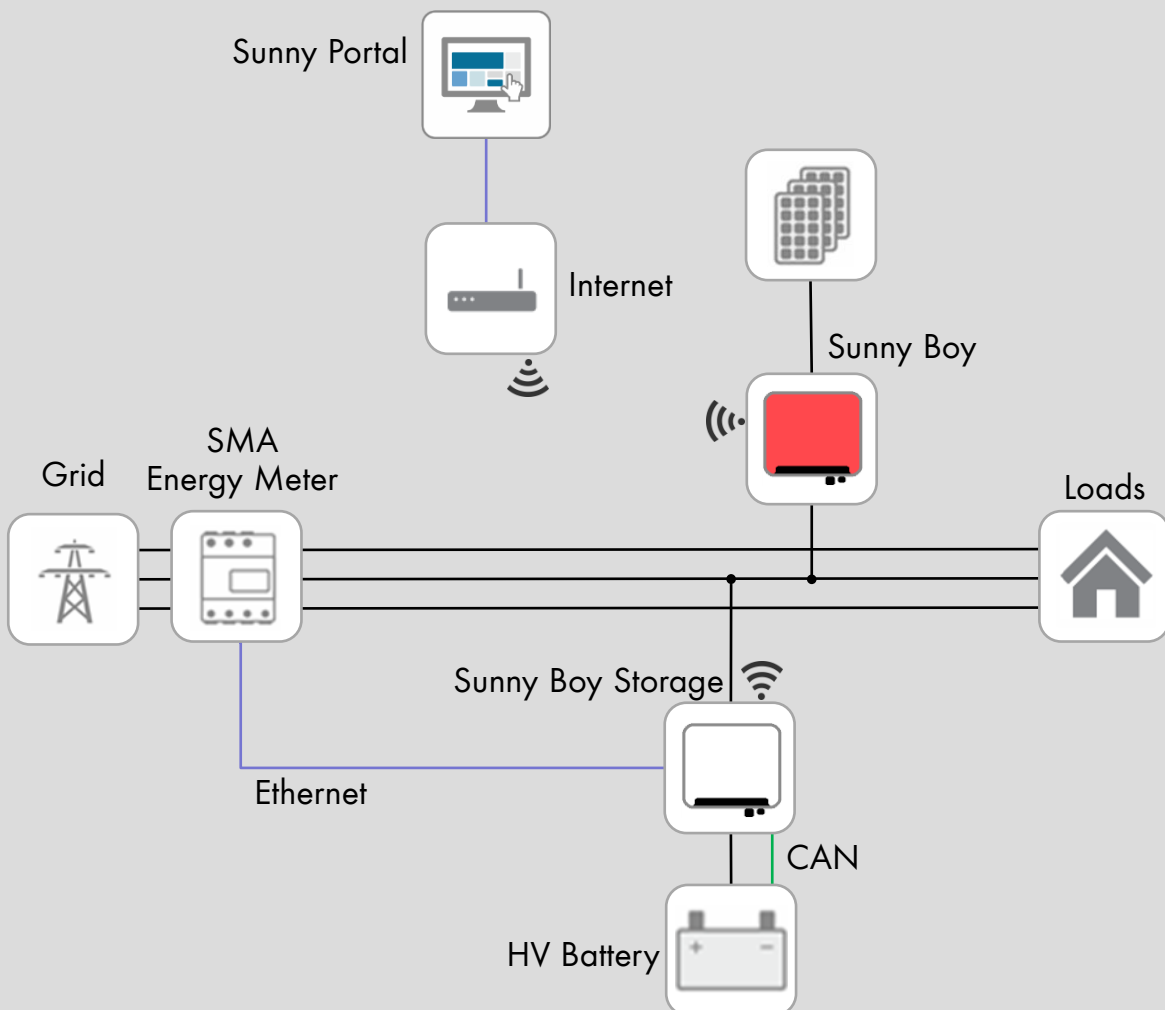

SUNNY BOY STORAGE



Full Function SMA System

System components

- > SMA 1ph or 3ph. PV-Inv. incl. Webconnect
- > SMA Energy Meter
- > Sunny Boy Storage
- > Sunny Home Manager (FM 1.30)

Functions

- > Control to the grid connection Point via SMA Energy Meter
- > Export limitation between 0-100% of rated power
- > Visualization Sunny Portal
- > Modbus third-party interface
- > CAN-BUS battery interface
- > With Sunny Home Manager
 - > Charge battery from grid time-window
 - > Weather forecast based charging

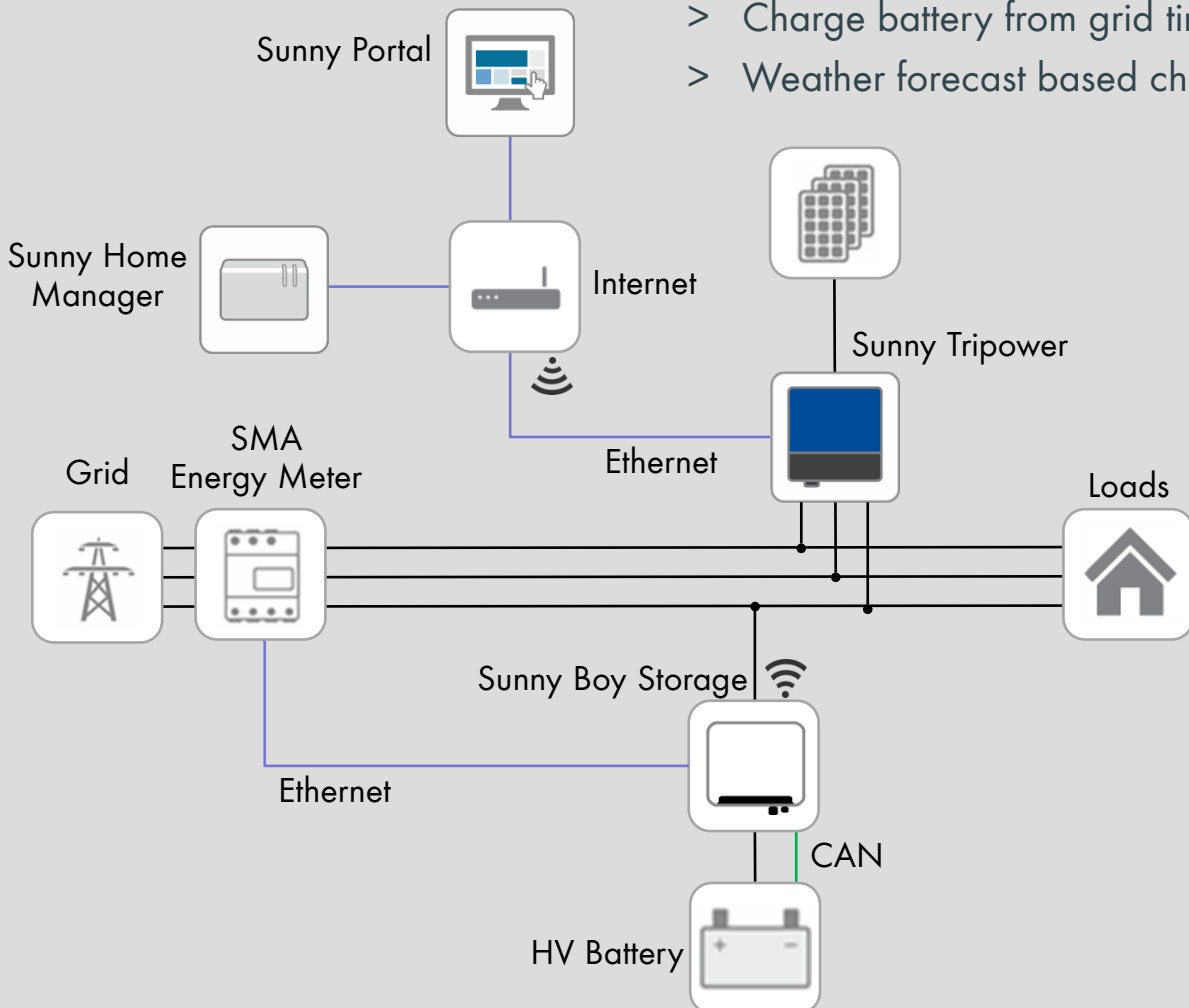

SUNNY BOY STORAGE



Full Function SMA System with Battery Backup (* via retrofit kit, exp. Q4 2016)

System components

- > SMA 1ph PV-Inv. incl. Webconnect
- > SMA Energy Meter
- > Sunny Boy Storage
- > Sunny Home Manager (FM 1.30)

Functions



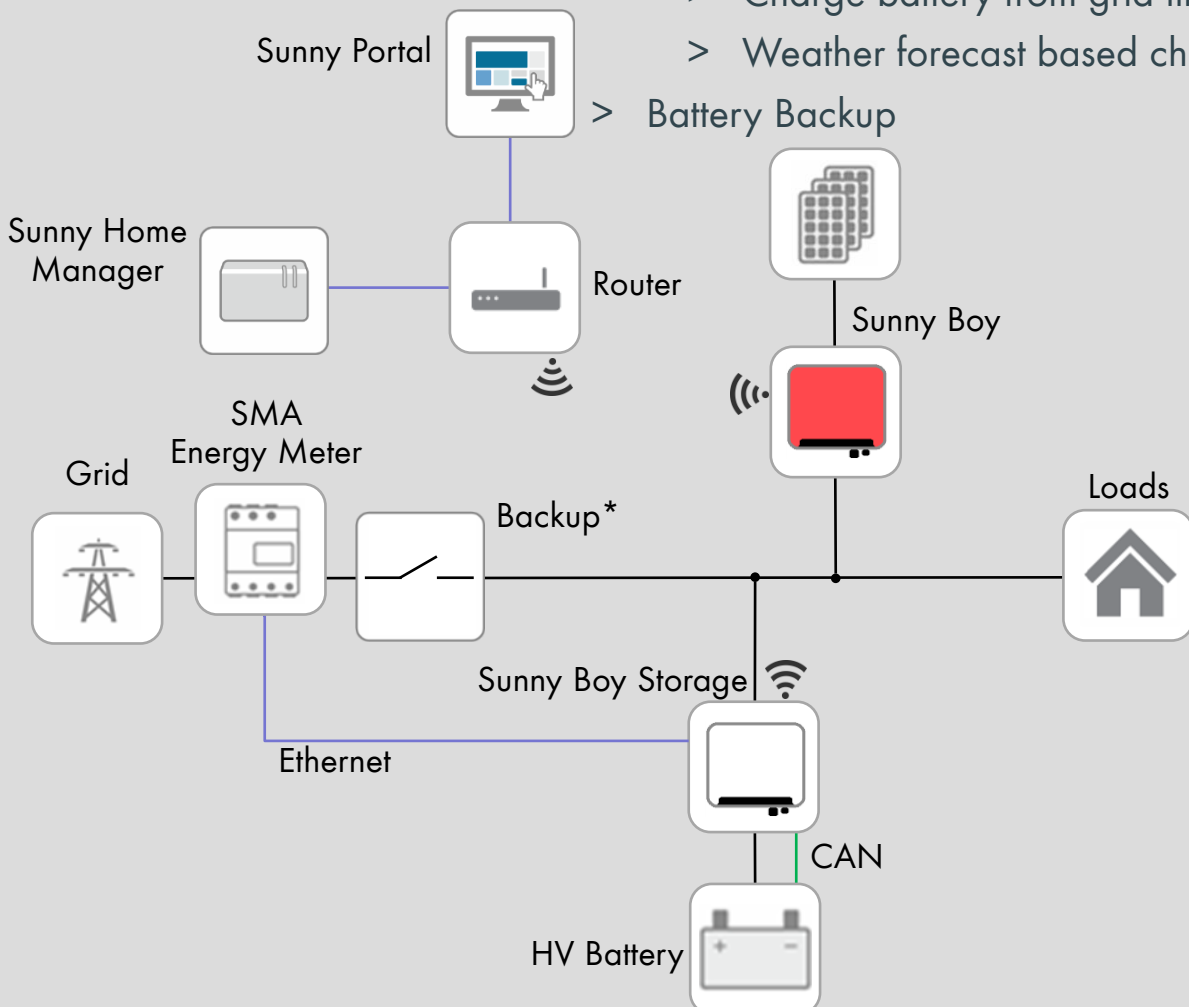































- > Control to the grid connection Point via SMA Energy Meter
- > Export limitation between 0-100% of rated power
- > Visualization Sunny Portal
- > Modbus third-party interface
- > CAN-BUS battery interface
- > With Sunny Home Manager
 - > Charge battery from grid time-window
 - > Weather forecast based charging
- > Battery Backup



Monitoring Visualisation in Sunny Portal Information

(with Sunny Boy Storage & SMA Energy Meter)



	Retrofit		New Installation		Storage without PV
		3rd Party		3rd Party	N/A
Battery Charge / Grid Export					
Battery Discharge / Grid Import					
Battery State of Charge					
PV System Generation	 *	 !		 !	N/A
Total PV + Battery Self-Consumption	 *	 !		 !	Battery Only
PV System Errors & Events	 *	 !		 !	N/A
Battery System Errors & Events					

* - For SMA inverters with Webconnect capability

! - Visualisation of 3rd party inverter possible only with second SMA Energy Meter and Sunny Home Manager